

# Vent A Hood SPECIFICATION SHEET

MODELS: PY18, PYD18 SlopeLine, PLX18, PLXH18 Professional, PL18, PLH18 Professional, ISF18, ISFH18 Flairline, C012, COH12 Straightline

## PY18/PYH18

SlopeLine

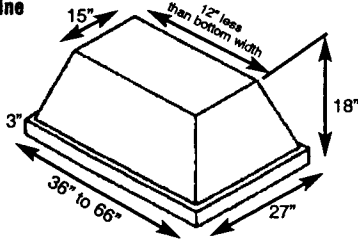

## PL18/PLH18

Professional

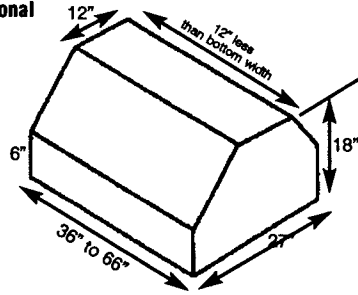

## ISF18/ISFH18

Flairline

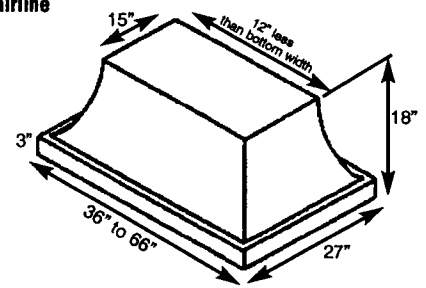

## C012/COH12

Straightline

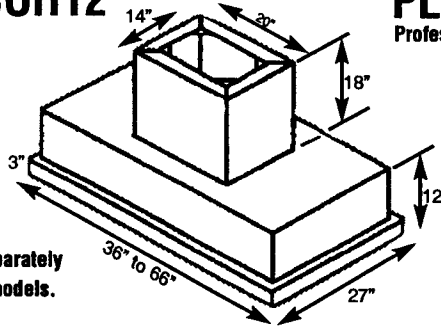

## PLX18/PLXH18

Professional

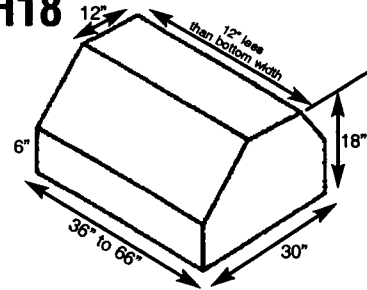

• Note: Duct Covers Priced Separately for C012/COH12 Straightline models.

### TOP VIEW - T200 Blower Exhaust Outlet Location

see page 11 in catalog for more information

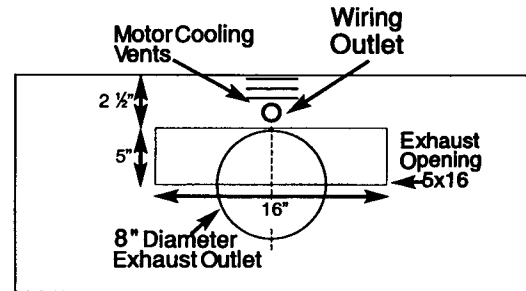
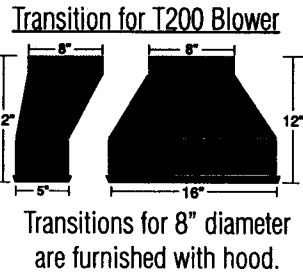

### ELECTRICAL/MECHANICAL SPECIFICATIONS FOR BLOWER UNITS

Model	Motor	Type	Volts	Amps	HZ	RPM	CFM SP@.0"	Equivalent* CFM	CFM SP@.1"	CFM SP@.2"	CFM SP@.3"	Minimum Round Duct Size	Square Inches
T-200 Dual	(2) 1/25	(2) Shaded Pole	115	3.4•	60	1550	600	900	572	540	480	8" (or equivalent)	50

• Note: Add 1.0 additional amp for each halogen bulb.

**Lighting:** 2 fluorescent lights furnished with each T-200 Blower or a total of 4 halogen lights per hood. No heat lamps are available for island models.

